



6150 Warehouse Way, Sacramento, CA 95826  
(916) 428-1708 \* FAX (916) 428-1728  
e-mail – tech.support@elevatorcontrols.com

**MODEL V800 TYPE PVF  
with  
YASKAWA - F7, VECTOR CONTROL DRIVE**

Manual for Start Up and Final Adjustment  
of the Elevator Controls V800- PVF Control Unit  
Used in Conjunction with  
**YASKAWA – F7 VECTOR CONTROL**  
Digital Drive

© 1995 Elevator Controls Corporation  
Rev. 05/06/2005

All information contained herein is confidential and is proprietary to Elevator Controls Corporation and is not to be used or reproduced without prior written consent of Elevator Controls.

# TABLE OF CONTENTS

Introduction	Page 3
Section I- Instructions for Installing and Adjusting Elevator	Page 6
I.2. Procedure for Startup of Microprocessor Control System	Page 7
I.3. Start-up for Yaskawa F7 Motor Drive	Page 9
I.4. Final Adjustment	Page 14
Section II	Page 18
II.1. Low Speed Safety Adjustment	Page 18
II.2. Motor Limit Timer Control	Page 20
II.3. Multiple Door Open Times	Page 20
II.4. Guide for performing Safety tests and inspection	Page 20
II.4.1. Full-load car buffer test	Page 20
II.4.2 . Empty car Counterweight buffer test	Page 20
II.4.3. Governor Test	Page 21
II.4.4. Full-load car safety overspeed test	Page 21
II.4.5. Emergency Terminal Stopping and speed limiting device test	Page 22
Section III- Troubleshooting Guide	Page 24
III.1. System Not Functioning In General	Page 24
III.2. Malfunctions in an Operating System	Page 26
III.2.1. Doors Operating Improperly or Not at All	Page 26
III.2.2. Drive problems	Page 27
III.2.3. Call Button Problems	Page 28
III.3. Microprocessor Troubleshooting	Page 28
III.3.1. Operational Logic Description	Page 29
III.3.2. Hardware Logic	Page 31
III.3.2.1. Computer Power Supply.	Page 31
III.3.2.2. Microprocessor Board.	Page 31
III.3.2.3. I/O Board (I/O-EX Board)	Page 31
Section IV: Detailed Explanation of Supervisory Subsystem	Page 32
Section V: Maintenance	Page 34
Section VI: Replacement Parts List	Page 35

# Introduction

## WARNINGS:

Throughout this manual, icons will be used to accentuate certain areas of text. These icons represent safety warnings, cautions, and interest areas. These icons are explained below:



**WARNING:** Denotes operating procedures and practices that may result in personal injury and/or equipment damage if not correctly followed.



**CAUTION:** Denotes operating procedures and practices that may result in equipment damage if not correctly followed.



**NOTE:** Denotes useful and informative procedures.

Throughout this manual it is assumed that the field personnel is well qualified in the installation of elevator equipment. No attempt has been made to define terms or procedures that should be well known to a qualified elevator mechanic.



**NOTE:** It is also assumed that the elevator counterweight balance has been properly checked and corrected as necessary; Speed governor device is installed and calibrated; Safety Clamp is properly tested; and all switches for slowdown, stop, and over travel limits at both terminal landings are checked for proper type, placement, and operation.



**CAUTION: The installation must be in compliance with all Local and applicable Elevator and Electrical Codes and regulations**

This manual is intended only to acquaint the service technician with the information required to successfully install the microprocessor-based elevator controller. The field personnel must be familiar with all codes and regulations pertaining to the safe installation and running of elevators.

Installation and wiring must be in accordance with the national electrical code and consistent with all local codes, and elevator codes and regulations. The 3 phase AC. power supply to this equipment must come from a proper fused disconnect or circuit breaker. Improper protection may create a hazardous condition.

Wiring to controller terminals must be done in a careful, neat manner. Stranded wire conductors must be twisted together to avoid strands from being left out of terminal and create potential shorts. All terminals and cable connectors must be checked to be sure they are seated properly. When connecting flat cable connectors be certain to match pin #1 marks (arrow symbol on connectors, red stripe on cable).



**CAUTION:** Please restrict access to elevator control equipment and apparatus to qualified personnel only.

# Introduction

The V800 Type P.V.F. system is a multi-computer network that controls the elevator. The P.V.F. uses a Dual Feedback Servo-loop from the elevator's speed and position to produce the optimum ride and performance. Figure I-1 is a block diagram of the P.V.F. multi-computer network.

Elevator Controls Position Velocity Feedback system is composed of three basic elements, in addition to the relay logic interface circuitry. These elements are:

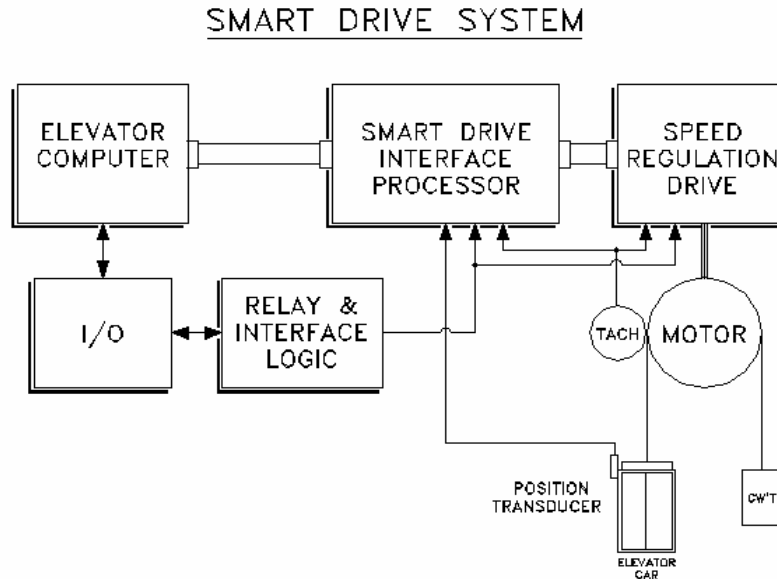

1. Elevator Car Controller Computer. It controls all of the elevator sequencing and signals. The elevator computer is the master computer, and tells the Smart Drive Interface (SDI) and the Speed Regulator what to do.

2. Smart Drive Interface (SDI). The SDI has the responsibility to generate the optimum speed pattern. The SDI receives quadrature pulses from the position transducer. The SDI keeps track of the elevator position to within 3/16 of an inch. This position along with field adjustable variables is used to generate an optimum speed pattern that is fed into the speed regulator. A manual titled SDI USER'S MANUAL is provided under separate cover to cover the SDI functions in full detail. You will need to procure a copy of the SDI manual to use as instructed in this manual.

3. Speed Regulator or drive system (Yaskawa – F7 drive, please refer to F7 Drive User Manual -herein referred to as "drive manual" for details on this drive). The speed regulator has the responsibility to make the elevator follow the speed pattern produced by the SDI and control the actual speed and ride of the elevator.

This Manual deals with the installation and adjustment of the complete system and it is intended for use in conjunction with the SDI and drive manuals captioned above.

**IMPORTANT:** The position transducer on cartop uses optical sensors to read tape-holes. It is important to keep the sensors and reflector clean from dust and debris, particularly on new installations

where dust and dirt is excessive. Do not grease the center of the tape that it may reflect or get optical readers dirty. Apply flat-black paint to the center row of the entire length of tape where tape-holes are located to avoid reflections due to hoistway-cartop illumination.

# Section I

## INSTRUCTIONS FOR INSTALLING AND ADJUSTING ELEVATOR

I.1. Protect printed circuit boards, and drive unit, from dust & foreign materials, remove fusing.



**CAUTION: BE CAREFUL NOT TO ALLOW METAL DEBRIS TO FALL ON CIRCUIT BOARDS**

I.1.1 Complete controller mounting, installation and wiring, observe controller field terminals location in relation to wiring ducts to determine where to cut holes for field wiring ducts.

I.1.2 Complete Selector installation and wiring, refer to instructions supplied with selector package for details. Connect DP1 and DPC each to one wire in the first shielded pair. Connect DP2 and DPC each to one wire in the second shielded pair. See your drive/SDI prints for a correct wiring schematic. Be sure shields are connected at all intermediate junction terminal strips for continuity from shield at selector to SDI terminal EGND.



**CAUTION:** Encoder mounting is very critical for closed loop systems. The encoder must track motor rotation accurately without slippage, bumping or vibration. On geared elevators, mounting to the back of the motor shaft is recommended. Refer to job prints for encoder wiring. Use multi-shielded-pair cable only, ground shield at controller end only as indicated. Improper mounting or wiring will create problems. Use separate metal, grounded conduit for encoder cable. **MISWIRING MAY DAMAGE ENCODER and void its warranty**



**NOTE:** Check job prints for any requirements for mounting of speed monitoring tachometer or magnetic speed pick-up unit. . Magnetic pick-up sensor is mounted using uni-strut to detect magnets glued on to motor shaft. In any case, you must use shielded cable to wire unit to controller.

I.1.3 Refer to any Supplemental Adjusting instructions.

## I.2. Procedure for startup of Elevator Controls Microprocessor Control System Model V800

These are not final adjusting instructions.

In the following instructions it is assumed that all hatch doors are closed but not necessarily locked, all hoistway and machine room wiring is complete. The car safety must be adjusted to the manufacturer's specifications and the governor installed and roped. Test the safety by hand to insure it will hold the car. Correct any malfunction before proceeding further.

These instructions also assume a minimum of electrical trouble-shooting experience and no attempt is made here to out-guess all the possibilities that may occur. Follow the procedure carefully and if the elevator does not respond correctly, check the circuits according to your ability. If you can't locate the problem in a reasonable time, call for an adjuster or serviceman experienced in trouble-shooting. Proceed cautiously. You will find the multiple L.E.D. indicators on boards and computer diagnostics very useful tools that will save you installation/troubleshooting time.

Read these instructions all the way through before starting to work to familiarize yourself with the procedure.

I.2.1 With power off, test all terminals for grounds. Also, test for shorts on terminals 4, 4A, 6, and 50 to each of the terminals on I/O board. If any are located, remedy the problem before proceeding or I/O boards may be damaged.

I.2.2 Make sure supervisory control system cards supply fuses are removed. At this point, flip controller insp and test switches to inspection and test position respectively (on).

I.2.3 Remove fuses F4, F50, F7, and F8 to disable primary controller relay voltage, and the door operator.



Note: Always check prints to double check fuse designation and correct amperage.

I.2.4. Check the line side of the disconnect and check that all three legs are at the correct voltage. Now turn on the disconnect and check the voltages at L1, L2, and L3 on controller. Check prints for detail on how input power connects to the drive and controller.

I.2.5. Turn power off and replace fuse F4, and fuses feeding SDI and computer power supply.

I.2.6. Familiarize yourself with the Elevator Controls SDI user's manual. The SDI computer system generates the speed pattern that is fed to the Motor Drive for speed control. The SDI computer receives commands from the elevator computer board along with relay contacts inputs to terminals UP, DN, and enable on terminal EX, as well as the inspection input INS. The SDI user's manual will help you familiarize yourself with the SDI programming, Hoistway "learning" (SETUP), as well as diagnostics and monitoring of its functions. You will note that there is a "Quick installation reference guide" intended for those who are already familiar with the controls system, drive system, and SDI system. It is also useful when replacing SDI boards only, when no Drive or Controller parameter adjusting is required. **DO NOT USE THE INSTALLATION GUIDE** in the SDI manual, unless you're familiar with Elevator Controls system or otherwise directed herein to do so. The guide in SDI's manual is for general reference purpose.



Note: The signal controls supplied to the SDI system are: UP, DN and ENA as well as INS (inspection mode). These inputs are connected via relay logic and are the minimum signals the SDI system needs to generate a pattern. These signals can be viewed at menu 3.4 and 3.6 on the SDI as shown:

**3.4 CONTROL SIGNALS**

UP = 0	LU=0	DZ=1	INS=1
DN=0	LD=0	DPS=01	EQ=0

**3.6 EDGE I/O**

EQS=0	PEN=0
MFW=0	ST=1

0= NOT ACTIVE  
1= ACTIVE

UP= UP DIRECTION  
DN= DOWN DIRECTION  
LU= LEVELING UP  
LD= LEVELING DOWN  
DZ= DOOR ZONE  
DPS= DIGITAL PULSES, DP1 & DP2 INPUTS

INS= INSPECTION INPUT  
EQ & EQS= EARTHQUAKE INPUT  
PEN= PATTERN ENABLE  
MFW= MOTOR FIELD WEAKENING  
ST= SDI READY WITH NO FAULTS

Note: ST indicates the SDI is ready and drives the SSAF relay in the safety circuit  
SDI will not output a signal voltage until PEN (Pattern enable) is active.  
MFW (Motor field weakening) is not used with AC drives.

If the ST, UP or DN, INS and PEN inputs are not active as you try to run the car in section I.3 below, then you will need to determine the cause. Normally an open safety string or open limit switch causes a problem here.

The SDI system needs a correct initial set-up; this is done at the factory. You should verify the set-up yourself before attempting to run on inspection. See SDI USER'S MANUAL Section 3 Program Variables. The following parameters must be set correctly:

- 1.1 Contract Speed (See SDI USER'S MANUAL section 3-3)
- 1.2 Number of Floors (See SDI USER'S MANUAL section 3-4)
- 1.13 Tach Polarity (See SDI USER'S MANUAL section 3-15)
- 1.14 Tach Gain (See SDI USER'S MANUAL section 3-16 -final setting of this parameter requires car to be running at contract speed, it is mentioned here because, if off limit, it can cause SDI safety relay to drop)
- 1.15 Tach Zero (See SDI USER'S MANUAL section 3-17).

I.2.7. The SDI pattern clamps need to be set correctly. This is not a final adjustment. The factory should set the clamps to the values below. Verify these values on the SDI system using sub-menu 2.5 Set Speed Clamps. Some clamps may not be used on your job; if your contract speed is less than the value shown below, that clamp will be unused. Turn trimpots for unused clamps fully counter-clockwise by 20 turns. See SDI USER'S MANUAL Section 3.6.

<b>Initial Clamp Settings Before Final Adjustment</b>			
Terminal & Resistor Number	Pattern Clamp	Terminal & Resistor Number	Pattern Clamp
U/D T1, R55	P = 20 FPM	U/D T8, R60	P = 700 FPM
U/D T2, R54	P = 100 FPM	U/D T10, R61	P = 800 FPM
U/D T5, R53	P = 250 FPM	U/D T12, R50	P = 1000 FPM
U/D T6, R58	P = 400 FPM	U/D T14, R57	P = 1200 FPM
U/D T7, R59	P = 600 FPM		

**I.3. Start-up for Yaskawa – F 7 AC Motor Drive**



I.3.1. Familiarize yourself with the drive manual. Pay particular attention to all safety precautions. Study the interface to the drive on Job prints, and note that the basic inputs to the drive are:

- i. Direction inputs (up, dn contacts)
- ii. Speed signal input (terminals A1 to AC on drive from SDI's terms. PUP and GND)
- iii. Power inputs to terminals R/L1, S/L2, and T/L3
- iv. Encoder inputs

The basic outputs are:

- i. 3-Phase output to motor through contactor
- ii. Fault output , drops DSAF relay if fault
- iii. Drive Run output
- iv. ABS Speed output ( Pins FM and AC, to SDI's TAC input)



**CAUTION: Do not connect building power supply to motor contactor.**



**CAUTION:** Power capacitors in drive remain charged for some time after power is removed, be very careful!

I.3.2. Familiarize yourself with the use of the drive's Digital Operator in chapter 3, Basic Programming in chapter 5 and Parameters in Appendix A of the drive manual to preset or change parameters using the Digital Operator keypad as necessary.

The drive can be set for “Operation only”, “User level” or “Advanced level” of programming. Please note that all of the drive programming parameters are accessible only from the Advanced Level. There is a “Quick” start menu that allows programming of a select list of parameters as listed in chapter 3-11 of the drive manual. The drive has been set for programming from the advanced level. Parameter access level can be set as in the drive manual's Initialization section, parameter # A1-01. Parameters listed with the access level as “Q” can be programmed thru the “Quick” or “Advanced” menus. Parameters listed with the access level as “A” can be programmed only thru the “Advanced” menu.

Parameters that are not listed in the following tables may not be used, or are used as programmed per the factory default value. Verify that the parameters are as listed on the F7 Programming List supplied with this elevator controller.

Parameters listed below have been changed from the factory defaults by Elevator Controls Corp. and except as noted (\*) must remain as changed for proper operation:

#### I.3.3.1. Analog inputs and outputs

Parameter #	E.C.C. Setting	Terminal #	Access Level	Comments
H3-01	0	A1	A	Speed reference input to term A1
H3-02	95 %(*)		A	Adjust to obtain rated speed
H4-01	5	FM	A	Motor speed output to SDI (TAC input)
H4-07	1		A	Set motor speed output to +10 to -10 vdc

#### I.3.3.2. Digital inputs

Parameter #	E.C.C. Setting	Terminal #	Access Level	Comments
H1-01	24	S3	A	External fault, N/O
H1-02	8	S4	A	External baseblock N/O
H1-03	F	S5	A	Not used
H1-04	F	S6	A	Not used
H1-05	F	S7	A	Not used
H1-06	15	S8	A	Fast Stop – decelerates using C1-09

#### I.3.3.3. Digital outputs

Parameter #	E.C.C. Setting	Terminal #	Access Level	Comments
H2-01	0	M1 – M2	A	Drive on - closed during run
H2-02	5	M3 – M4	A	Output to turn on LSSM speed monitor
L4-01	10 Hz(*)		A	Freq to LSSM –Low speed safety monitor

#### I.3.3.4. System Constants

Parameter #	E.C.C. Setting	Access Level	Comments
A1-02	3	Q	Flux Vector Mode. Requires encoder.
B1-03	0	Q	Ramp to Stop.
C6-01	1	A	Normal duty
C6-02	3	Q	Carrier Frequency – adjust for motor noise
L3-04	0	Q	Deceleration Stall disable.
L5-01	2	A	Auto resets. Set to 2 or desired # of auto-resets
L5-02	1	A	Fault Relay Active during auto-reset
L6-01	2	A	Alarm @ Run on over-torque detection.
L6-02	250 %(*)	A	Torque detection level.
L8-07	0	A	Output phase loss disabled

#### I.3.3.5. V/F Pattern.

Parameter #	E.C.C. Setting	Access Level	Comments
E1-01	Line Voltage	Q	Set to proper line Voltage
E1-04	60	Q	Maximum Frequency = 50 for some Countries.
E1-05	Motor Voltage	Q	Set to Motor Nameplate voltage
E1-06	60	Q	Base Frequency = 50 for some Countries.
E1-09	0.0 Hz	A	Minimum frequency

#### I.3.3.6. Motor Setup

Parameter #	E.C.C. Setting	Access Level	Comments
E2-01	Motor Amps	Q	Motor full load amps on nameplate
E2-02	Motor Slip	A	If unknown = 60-(F.L.rpm X # of poles/120)
E2-03	No Load Amps	A	If unknown = 35% of E2-01 value
E2-04	# of Motor Poles	A	60 Hz - 900 rpm = 8, 1200 rpm = 6, 1800 rpm = 4

#### I.3.3.7. Encoder Setup

Parameter #	E.C.C. Setting	Access Level	Comments
F1-01	1024	A	Encoder Pulses per Rev
F1-02	0	A	Ramp to stop with PG Fdbk loss
F1-03	0	A	Ramp to stop with PG overspeed
F1-04	0	A	Ramp to stop with PG rspeed deviation
F1-05	0(*)	A	PG rotation; 0: up = CCW, 1: up = CW

#### I.3.3.8. Gain parameters

Please note that the gain parameters listed below, may need to be fine-tuned during final adjustment procedure.

Parameter #	E.C.C. Setting	Access Level	Comments
C1-01	0.0 sec	Q	Acceleration time 1
C1-02	0.0 sec	Q	Deceleration time 1
C1-03	0.0 sec	A	Acceleration time 2
C1-04	0.0 sec	A	Deceleration time 2
C1-09	0.0 sec	A	Fast stop time
C2-01	0.00 sec	A	S-curve at acceleration start
C2-02	0.00 sec	A	S-curve at acceleration end
C2-03	0.00 sec	A	S-curve at deceleration start
C2-04	0.00 sec	A	S-curve at deceleration end
C3-01	1.0	A	Slip Compensation gain
C5-01	20.00	A	Automatic speed regulation gain
C5-02	0.500 sec	B	Automatic speed regulation "dampening" time

I.3.4. Place controller on inspection (by setting controller RUN/INSP switch to INSP). Check the main safety circuit to see that the SAF relay in the controller is picked. Refer to the safety circuit on the job prints and notice that contacts of the DSAF relay, that is set by the motor drive, and the SSAF relay, that is set by SDI, are in the safety circuit. The SAF relay will pick when the safety circuit is closed and no faults exist.

I.3.5. Run the car in inspection mode by using the up/dn switch on the controller (jump the door locks and normal safety limits if necessary to complete the run circuit). The car top, in-car and access inspection switches must be off for the controller up/dn switch to work. If the car runs backwards, reverse any two of the field wires from motor to contactor.



**CAUTION:** Make sure the motor rotation is correct and that it does not produce unusual noise or vibration, refer to the drive manual for Fault Indication details. If the encoder

direction of rotation is incorrect, the drive will probably trip off or the car may move at a very slow speed, irrespective of setting. If so, change the encoder direction parameter F1-05 from 0 to 1, or vice-versa. If still a problem, check wiring of encoder signals. Verify proper operation.

I.3.6. While attempting to run, adjust brake volts to desired value (refer to original data for the job). See prints for any brake voltage adjustment resistors.

I.3.7. Set inspection speed to zero, SDI parameter 1.12. Adjust parameter E1-09, if necessary, to hold car at or near zero speed.

I.3.8. Gradually increase inspection speed, SDI's program variable 1.12, to observe performance (do not exceed 100 FPM). Setting of 20 to 50 FPM is desirable during installation phase. If motor vibrates, try reducing proportional gain C5-01, if no effect, return it to previous value and advance C5-02 slightly. At this point, check some of the monitoring parameters "Un" as listed in drive manual such as output current U1-03, and speed deviation U1-23.

I.3.9. Prove that the brake will properly hold at least an empty car, perform any necessary adjustments to get proper brake operation.

I.3.10. Now inspect up. Measure car speed on the governor rope with a hand held tachometer. Now, refer to SDI's manual section 5, to select display 3.1, tracking performance. The tach display needs to agree with the actual car speed. Adjust tach gain -SDI section 3.16- if display is incorrect.

I.3.11. Remove jumper 4A-24 and check the primary safety circuit (all items) and repair as necessary. Check car-top stop switch and up and down buttons. Inspect full length of hoistway for free running clearances. Check all door locks.

I.3.12. Check inspection access operation (if provided) including proper door lock bypassing.

I.3.13. Be sure TM switches or slowdown limits, stop limits, and overtravel limits are all properly set according to hoistway print.

I.3.14. BE SURE CARD CONNECTORS ARE SNAPPED IN ALL THE WAY. Verify all connectors in the system are correctly seated, if you haven't done so before. Ribbon and plug-in field wire connectors can wiggle loose when the system is being worked on. Press firmly on all connectors to seat them. Be sure duplex cables are installed along with any #18 wire cross connections (If more than one car) according to hoistway print. Install F50 fuse if used on this controller.

**At this point the system should run correctly on inspection. If you are still having problems, review steps above and repeat as necessary.**

Before running the system on automatic, follow steps I.3.15 through 23, as well as the procedure for final adjustment of the elevator, Section I.4.

I.3.15. Set the leveling switches on the car top to give proper dead zone, +/- 1/4". For PVF system, LU and LD need to be off (0 VDC) when the car is level. The vane or magnet lengths and switch arrangements are specified correctly on your job selector information. Use two twisted shielded pairs for

the digital pulse output from the selector. Connect DP1 and DPC each to one wire in the first shielded pair. Connect DP2 and DPC each to one wire in the second shielded pair. DP1 and DP2 are each labeled on the SDI system and the selector. DPC on the SDI system connects to MINUS (-) on the selector. See your drive/SDI prints for a correct wiring schematic. Be sure shields are connected at all intermediate junction terminal strips for continuity from selector box to SDI EGND terminal. If optical sensors are used the tape should be painted flat black, from top to bottom, in the hole area of the tape, to avoid light reflections from activating the optical sensors. Be sure reflector and optical sensors on selector stick are clean.

You cannot set the re-level speed yet; the PVF system will not run when on automatic.

I.3.16. Test the DP1 and DP2 inputs to the SDI. Use sub-menu 3.8 Target and Position. Run the car up on inspection; verify that the DP (digital pulse) value goes up and it is positive. Run car down on inspection; verify that the DP value goes down. If the DP value goes in the wrong direction, or increases negatively when going up, reverse the DP1 in DP2 wires on the SDI system.

I.3.17. The door operator must be correctly adjusted. Remember to reinstall the door fuses. Clutches must have proper clearances for running in the hoistway. Check the print for any special instruction on your job.

I.3.18. Make sure all hoistway doors and car doors are closed and locked. Run the car on inspection mode through the entire hatch, making sure it is clear of obstructions. Door zone and level vanes should already be installed and adjusted to level the car within 1/4" of the floor.

I.3.19. The SDI system now needs to learn the hoistway. This procedure is fully detailed in the SDI USER'S MANUAL Section 4.2 Set Up Mode. Note terminal posts JMP2, SDI LEARN JUMPER, has been provided on the DAB board and needs to be jumped together to perform this Set Up procedure. Be sure to remove jumper after completing the Set Up procedure. Be sure normal stop switches do not open before car is fully level at terminal floors, and allow for approximately 2 Inches of overshoot in either direction.

I.3.20. After completing step 19 above, verify that the floor position table is correct. Use sub-menu 2.2 Floor Position Table on the SDI system. Press the UP button on this menu, observing the recorded position for each floor. The floor positions are shown in two ways: feet (FT) and pulses (P), about 3/16 inch per pulse. These values should be reasonable and correspond to what you would expect the floor heights to be. Any of the following indicate a problem.

1. *Floor positions are not as expected.* Floor heights are measured relative to the bottom limit and should increase, If not as expected, check your field wires, especially DP1, DP2, DPC, EGND and door level switches. Be sure DP1 and DP2 shields are connected properly.

2. *Floor positions decrease or are negative. Pulse counts are less than 1000P.* Floor distance should start at 0 ft or 1000 pulses at the bottom limit and increase from there. Reverse DP1 and DP2 field wires if count is negative and then go back to step 17. Repeat steps 20 and 21 once you find the problem.

I.3.21. Verify that the terminal slowdown position table is correct. Use sub-menu 2.3 Terminal Position Table on the SDI system. Press the UP button on this menu, observing the recorded positions for each terminal. Like the floor position table, these values should be reasonable and correspond to what you would expect the terminal positions to be.

If you do find a problem, check your field wiring. Verify that the slowdowns are set in the correct positions. Go back to step 19 and repeat steps 19, 20 and 21 once you have found the problem.

I.3.22. Now move the car on inspection to the second level. Move the TEST switch to the on position. This will put the system on independent mode when inspection mode is turned off. TEST also disables door opening (TEST mode does NOT disable door closing). Move the car below the floor, onto the leveling input with the inspection switch, and then turn inspection off. The car should re-level up into the floor. Check that the relays sequence properly for re-leveling and adjust the program variable 1.11 Re-level Speed for accuracy and comfort.

Put the system back on inspection and repeat step 22 as needed. Then repeat by moving the car above the floor to get a re-level down, repeating as needed.

I.3.23. Turn inspection mode off (TEST should still be on from step 22). Place a car call one floor above the second level. The car will run up from the second level and slowdown into the third floor. Observe how the system responds, especially the brake, motor and sheave. Decide what part of the system needs to be adjusted first and focus on that as you perform final adjustment below. You may need to stop and readjust other parts of the system during this procedure. Any problems with the brake or door clutch clearances will become apparent here. Correct these problem as they come up before continuing with this adjustment.



NOTE: to place car calls from the machine room, jump from IO-6 Call GND post, located on the top right corner of the board, to the car call field terminals on the I/O-6 board. TEST mode requires a constant car call input to run the car. Note that TEST also has a software noninterference timer (five to fifteen seconds) during which the system will not respond to a new call.

The noninterference timer is located in memory address FF9C, and can be modified to a 2 second value to allow faster response to car calls while the car is operating under test mode; Please be sure the timer is reset to the pre-modified value before car is turned off from test mode of operation. Please refer to Field Reprogramming manual for instructions on how to use the Direct Access mode of the 'On Board Diagnostics' tool.

If car does not respond, refer to "Elevator Controls' Guide to Error Condition Codes" sheet which will aid the adjuster in determining why the elevator is not responding. Pay particular attention to the multiple L.E.D. indicators on the I/O board. If car is leveling, the LVL indicator will be off, and car cannot respond until leveling process is complete. If none of the door opening devices or call input is active, the corresponding indicator will be lit. If the SD (or SU for up) indicator is on and Down relay is not picked, check normal limit switch. Also check DSD2 and USD2 LED's, they must not be both off or reversed. These are the corresponding terminal landing slowdown switches that open when car is at corresponding terminal floor. Pay attention to liquid crystal display on elevator computer board.

## I.4. Final Adjustment

(Read thoroughly before continuing)

- Verify leveling switches on cartop to give proper dead zone (+/- 1/4")
- Be sure TM switches or slowdown limits, stop limits, and overtravel limits are all properly set according to hoistway print.
- Check Access operation (if provided) including proper door lock bypassing.

I.4.1. Place car on inspection at bottom landing. Put 2/3rds of contract load in the car. Now start adding weights in 50 or 100 pound increments and moving car on inspection each time UP and DN. Adjust brake tension to stop and hold 125% of contract load by tripping any stop switch except car stop switch open while running down on inspection. Hold the "DOWN" button in while you trip open the stop switch (preferably on the inspection station). The car should stop on the brake.

With the car loaded with 125% of contract load, set the inspection speed in the SDI = Leveling speed (approximately 4 FPM) and verify that the car will move up and down with the load at approximately the same speed. If the car does not move up, increase parameter C5-01 ASR Proportional Gain 1 on the Motor Drive.

Return the inspection speed to the desired value. Change from inspection operation to TEST mode with car at floor level. Run the car with one, and multiple floor runs as you make adjustments below to "mold" speed curve.

If the car does not run physically (as monitored with a tachometer) at the rated speed set in parameter 1.1 of the SDI, adjust the motor drive parameter H3-02 "Terminal A1 gain".

You will need to make sufficient runs to be sure that the system responds how you want. Take your time here; adjustment procedures are not inherently quick.



NOTE: a dual-trace storage oscilloscope can be a great help here. Observing the pattern output and the tach from the drive can save a lot of time and hassle. Connect one probe to terminals A1 and AC on the TB connector on the Motor Drive, this is the pattern signal and is a 0 to +10 volt DC signal, with +10 volts being contract speed.

Connect the second probe to the Motor Drive feedback signal at pin FM on the TB connector. This signal is -10 to +10 volts DC with +10 vdc being contract speed in the UP direction.



**CAUTION:** If grounding pin on your oscilloscope plug is electrically connected to the negative probe lead, then you MUST NOT attempt to connect the negative lead to the equipment or damage will occur. In this case, if your scope has 2-channels with channel B invert feature active, remove negative leads from probes, press A+B button on scope. Use A and B probes to measure signals.



NOTE: a pair of hand-held radios and a helper can be a great help. After the speed pattern is adjusted as well as possible from the machine room, the adjuster should ride the car while a helper adjusts the system per the adjuster's instructions. There is simply no substitute for riding a car while adjusting.

The speed profile drawing, Figure I.4.1 below, provides information, at a glance, of the parameters involved for the adjustment of the elevator ride. Please use as reference.

## SPEED CURVE PARAMETERS

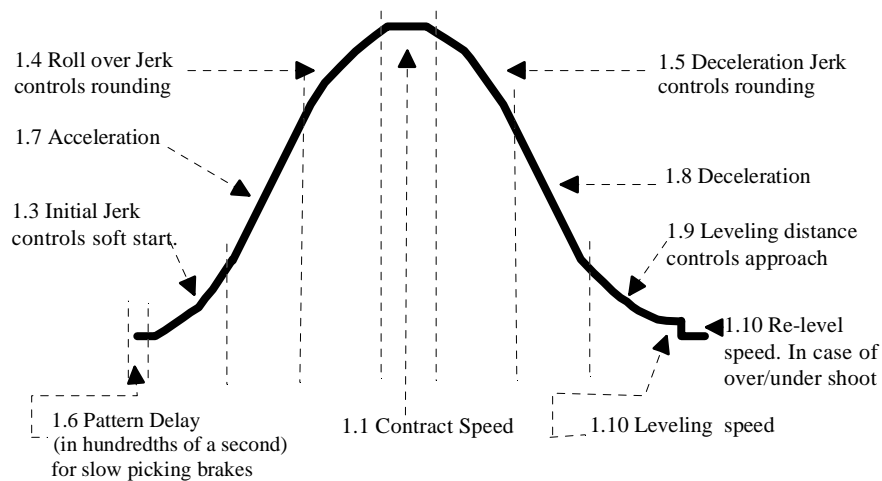



FIGURE I.4.1

I.4.2. Make a series of test runs: up one floor, then down one floor; then a multiple floor run up, then down. At every run adjust, as necessary, any of the speed curve parameters depicted on figure I.4.1 below. Refer to SDI's manual drawing "SDI SUBMENU 1", at end of SDI manual, for quick reference about "navigating" through program variables, submenu 1. If car vibrates, check encoder mounting and wiring, if correct, reduce ASR Gain adjustment, parameters C5-01 (refer to page 28 in the drive manual). As soon as car is able to run at top speed, perform step I.4.3 below, and then repeat this step as necessary.

 CAUTION: Higher numbers (higher gain) may cause oscillation, lower numbers cause sluggish response.

I.4.3. Now, while making a long floor run, verify that cars run at contract speed when 10 volts is applied to Motor Drive connector terminals A1 to AC. If not, readjust parameter H3-02, Terminal A1 gain, on the drive to get contract speed as measured on the governor rope.

I.4.4. Now that car is running at contract speed from step I.4.3, the SDI's tach speed display must be checked to agree with car speed. Refer to SDI's manual section 3-16 to adjust Tach Gain, if necessary.

I.4.6. The car should now be running at contract speed with no overshoot on acceleration and should be undergoing a reasonable deceleration. The idea is to get a smooth overall deceleration into the leveling zone, but to not spend much time at a steady leveling speed.

I.4.7 Adjusting the speed pattern can be more of an art than a science. You have two goals: ride comfort and brake-to-brake time. You will have to decide which to work on at any one time. The two goals are not exclusive; you can achieve both. The section below, provides the adjuster with information and hints to fine-tune elevator for best performance and comfort. Please read thoroughly and make any adjustments needed.



As you adjust the parameters below, refer to the relevant sections in the SDI USER'S MANUAL.

These sections contain explanations and illustrations to help you adjust the system.

### **Decreasing Brake-To-Brake time:**

A. Increase 1.7 Acceleration. See Section 3.9 in SDI's manual.

 NOTE: When you do this, you will probably have to increase 1.3 Initial Jerk and 1.4 Roll-Over Jerk. The jerk values should be 1 to 2 times the Acceleration value. Example: if Acceleration is set to 200 FPM/s, Initial Jerk and Roll Over Jerk should be set between 200 FPM/s/s and 400 FPM/s/s.

B. Increase 1.3 Initial Jerk and 1.4 Roll- over Jerk. See Section 3.5 and Section 3.6 in SDI's manual.

 NOTE: Both of these parameters should be changed whenever 1.7 Acceleration is changed significantly. For quick brake-to-brake times, use 1.4 to 2 times the Acceleration value. Higher jerk values will cause the pattern to reach contract speed quicker.

C. Increase 1.8 Deceleration. See Section 3.10 in SDI's manual.

 NOTE: your Deceleration value will probably have to be 25 to 50 FPM/s less than your Acceleration value. This improves passenger comfort and also makes final approach into the floor more accurate.

D. Decrease 1.9 Leveling Distance. See Section 3.11 in SDI's manual.

 NOTE: The leveling distance is used in place of a final (stopping) jerk. An oscilloscope is very useful for viewing the shape of the final curve. Also, leveling distance is measured in pulses from the tape, 3/16 of an inch per pulse. You'll have to make larger changes of this value-at least six to ten pulses-to see any change in performance.

 NOTE: Leveling distance must always be greater than 16, which is only 3" of controlled floor targeting. Leveling distance should normally always be greater than 32. A good working range is 72P to 38P.

### **Passenger Comfort**

A. Increase 1.6 Pattern Delay. See Section 3.8 in SDI's manual.

 NOTE: This is only useful if the car is pulling through the brake when the pattern starts. Increasing pattern delay will wait for a given amount of time, allowing the brake to pick..

B. Decrease 1.10 Leveling Speed. See Section 3.12 in SDI's manual.

 NOTE: Leveling speed is set high at the factory so a car won't stall coming into a floor. You will need to decrease leveling speed to about 4 FPM to eliminate the bump when stopping in most systems.

C. Decrease 1.3 Initial Jerk. See Section 3.5 in SDI's manual.



NOTE: Excessively high jerk values can cause passenger discomfort.



NOTE: Some motor systems can not follow high jerk values. The resulting overshoot can cause bumps during the ride. You need a dual trace storage oscilloscope on the TAC input to the SDI system to determine this. Decrease the initial jerk until you can see a smooth start on the tachometer from the drive.

D. Decrease 1.4 Roll Over Jerk. See Section 3.6 in SDI's manual.  
See part C above for hints on how to do this.

E. Decrease 1.5 Deceleration Jerk. See Section 3.7 in SDI's manual.  
See part C above for hints on how to do this.

The adjustment should now be complete. Verify and correct proper floor leveling, and make sure door zone sensors are adjusted to prevent door pre-opening outside +/- 2" from floor level



**NOTE: if you change any door zone or floor sensors, the hoistway will need to be relearned. See paragraph I.3.20.**



**CAUTION: IT IS RECOMMENDED TO ELIMINATE ANY PRE-OPENING AT ALL, UNLESS SPECIFICALLY SPECIFIED. THE V800 CONTROLLER HAS A JUMPER OPTION FOR JOBS REQUIRING PRE-OPENING (SEE PRINTS).**

I.4.8. After ride adjustment above is complete, the pattern clamps must be adjusted. With TEST mode still on, run the car to the bottom floor. Then make one complete run of the hoistway up to the top terminal. Run back down to the bottom terminal in one run. Now use sub-menu 2.5 Set Speed Clamps on the SDI system. The system will display the proper value for the speed clamp and the potentiometer to adjust. Note: these values will be different than those set as initial values in step 3. This time you will use the displayed value for T1 through T14. Press the UP button on the SDI system and repeat for the next clamp. Repeat until all of the clamps are adjusted.



**NOTE: if you change any velocity pattern variable, the clamps may need to be readjusted. Repeat this step any time you adjust Initial Jerk, Acceleration, and Roll-Over Jerk, Deceleration Jerk, Deceleration or Leveling Distance.**



**CAUTION:** Verify all connectors in the system are correctly seated, if you haven't done so before. Ribbon and plugable field wire connector can wiggle loose when the system is being worked on. Press firmly on all connectors to seat them.

# SECTION II

## II.1. Low Speed Safety Monitor Adjustment

 NOTE: The Low Speed Safety Monitor (LSSM) contains several circuits required by code, ANSI/ ASME A17.1, and other safety circuits and therefore should be adjusted carefully, The safety monitors of the LSSM are:

1. Elevator Overspeed
2. LSSM Tachometer Monitor
3. Leveling Disable
4. Leveling and Inspection Overspeed
5. Terminal Slowdown monitor

 **CAUTION: The following adjustments should not be attempted until the final adjustment of the car is complete or this procedure will have to be redone.**

 NOTE: TP-8 is ground, all measurements are to be made with the negative lead attached to TP-8. Do not use any other ground point for this purpose. If an oscilloscope is used, be certain that the ground lead is isolated from the line or the board will be damaged.

 **CAUTION:** Verify: Jumpers J1 & J2 on the LSSM board are in place. Be sure to remove jumper when adjustment is complete.

### II.1.1.A Set Up utilizing Pulse Input:

 NOTE: **Skip to II.1.1.B if Tachometer is used for speed monitor feedback.**

Jumper J3 on the LSSM board is set to "FREQ".  
"TEST" switch on HLS (relay) board is on; this disables door operation.  
Make a multi-floor run so that the car achieves contract speed and measure and record the **highest** voltage on TP-6 with respect to TP-8 on the LSSM board.

### II.1.1. B. Set Up utilizing Tachometer Input:

 NOTE: **Skip to II.1.2 if Pulse Input is used for speed monitor feedback.**

Jumper J3 on the LSSM board is set to "VOLTAGE" and resistor R45 is installed.  
"TEST" switch on HLS (relay) board is on; this disables door operation.  
Make a multi-floor run so that the car achieves contract speed and set VR6 so that the voltage on TP-6 with respect to TP-8 on the LSSM board. is approximately 8 volts.

II.1.2. OVERSPEED potentiometer setting: with the car running at contract speed, turn the "OVERSPEED" trimpot CCW until the board does an Overspeed trip. The "OVERSPEED" LED and the "SAFETY TRIPPED" neon should be lit. This verifies that the Overspeed circuit is working. Now multiply the tach voltage recorded from II.1.1 above by 1.15. Set the "OVERSPEED" trimpot to give that voltage at TP-3. This sets the Overspeed trip point to 115% of maximum normal speed.

II.1.3. TACH LOSS potentiometer setting: The SCR Drive is set to activate the output tied to the LSSM board's "AS" input at 5% of contract speed (parameter 3.23). While making one floor runs, slowly turn the "TACH LOSS" trimpot CW until the board does a tach loss trip. This verifies that the LSSM tach loss circuit is working. The motor drive has it's own "Tach Loss" monitor. Multiply the voltage recorded from II.1.1 above by 0.03. Set the "TACH LOSS" trimpot to give that voltage at TP-1. Put the car on test and make several runs to verify that there is no tach loss tripping.

II.1.4. LEVEL DISABLE potentiometer setting: Put the car on inspection and position it on a leveling vane. Ground TP-5. This should make the "LEV DISABLE" LED light. Remove jumper J2 from the LSSM board. Put the car back on test. The car should not move. Remove the ground jumper from TP-5. The car should now level into the floor. This verifies that the leveling disable circuit is working. If the contract speed is below 500 fpm, multiply the voltage recorded from II.1.1 above by 0.3. If the contract speed is 500 fpm or more, multiply the voltage by 0.2. Set the "LEV DISABLE" trimpot to give that voltage at TP-5. This sets the leveling disable threshold to 30% or 20% of maximum normal speed, depending on the contract speed.

II.1.5. LEVELING and INSPECTION OVERSPEED potentiometer setting: Put the car on inspection. While running the car, turn the "LEV/INSP" trimpot CCW until the board trips. The "LEV/INSP" LED and the "BOARD TRIPPED" neon should be lit. This verifies that the leveling and inspection Overspeed circuit is working. Leave the board in the tripped state. With the car stopped, remove the jumper from J1. The SAF relay should drop. Replace the jumper. Put the car on test. Make a multi-floor run and measure the voltage at TP-6 when the car speed has stabilized after any initial speed overshoot. This is the tach voltage when the car is running exactly at contract speed. Multiply that voltage by 140. Divide the number you get by the contract speed of the elevator. This is the tach voltage at 140 fpm. Set the "LEV/INSP" trimpot to give this voltage at TP-4. This sets the leveling and inspection speed trip point to 140 fpm.

EXAMPLE: Contract speed = 400 fpm  
Tach Voltage @ contract speed = 5.00 V  
 $5.00 \times 140 = 700$ ;  $700 / 400 = 1.75$  (the answer)

Set TP-4 to 1.75 V.

II.1.6. TERMINAL SLOWDOWN potentiometer setting: Check the controller prints to see if the "SLDN" terminal on the LSSM board is tied to 4A bus. If it is, skip this adjustment.

While making multi-floor runs into either of the terminal landings, turn the "SLOWDOWN" trimpot CCW until the board trips as the car slows down on approach to the terminal. Now turn the trimpot back about a half a turn at a time until the board doesn't trip on terminal slowdown. Measure the voltage at TP-2 and turn the "SLOWDOWN" trimpot until it rises 0.1 V. *EXAMPLE:* If the 'non-tripping' voltage at TP-2 is 6.50 V, set it to 6.60 V. Now make multi-floor runs into both terminal landings and see that the board does not do a slowdown trip. If the board does trip, increase the voltage at TP-2 in .1 V steps until it does not trip. Finally, check to see that the voltage setting on TP-2 is less than or equal to the voltage recorded from II.1.1 above.

II.1.7. Remove jumpers J1 & J2 from the LSSM board. The adjustment is complete.



NOTE: The LSSM board has two fault indications. If a fault occurs momentarily, the associated LED will illuminate and stay lit as a warning, the safety circuit will not open until the fault is maintained for at least 0.4 seconds. This is indicated by the neon lamp.

## II.2. Motor Limit Timer Control

If car is running and fails to reach its call within a pre-determined time interval, the controller will automatically stop the motor, further operation of the elevator is prevented until the trouble has been corrected by cycling the inspection switch or power disconnect. The computer error code LED indicators and LCD (if provided) will display the corresponding error status. This timer is factory preset for 120 seconds, refer to Field Re-programming Manual for instructions on adjusting this timer on-site.

## II.3. Multiple Door Open Times

The V800 controller is equipped with selective door timing for car, hall, and short door open times. The factory pre-set values are field-adjustable through the use of the ON-BOARD diagnostics unit. Refer to Field Re-Programming Manual for complete detail. Check door open times for proper operation and in conformance with handicapped and applicable codes.

## II.4. GUIDE FOR PERFORMING ELEVATOR SAFETY TESTS AND INSPECTION

 NOTE: The following procedure is intended as a guide while performing periodic inspection and safety tests of elevator. Please refer to Safety Code for Elevators and all applicable local codes for requirements.

 CAUTION: Safety tests should be accomplished by a qualified adjuster or serviceman. A helper should always be present and prepared to turn-off the main line disconnect to remove power from the elevator if needed **when the car is run with safety switches bypassed**. Proceed with caution.

 NOTE: For the following safety tests, II.4.1 thru II.4.5, remove the wire from terminal Rd when Absolute Floor Encoding is used. Reconnect the wire to terminal Rd when safety tests are completed.

### II.4.1. FULL -LOAD CAR BUFFER TEST

II.4.1.1 Put full load in car; place controller test switch to test position.

II.4.1.2. Call elevator to a floor several floors up from bottom, except top floor.

II.4.1.3. Jumper terminal 4A to all down slowdown switches terminals (DSD1, DSD2, and DT6 thru DT14 if used for higher speeds).

II.4.1.4. Identify and remove signal DP1 from SDI terminals.

II.4.1.5. Place controller inspection switch to inspection, and run car one or more floors down to a floor level. Be sure DZ relay is picked. Reconnect DP1 and place controller inspection switch to normal.

II.4.1.6. Place jumper from controller terminals 17 to 23. This bypasses safety switches. Also, jumper terminals 29 to 33, to bypass down normal limit.

II.4.1.7 Place a car call to bottom floor to run car into buffer. After car strikes buffer and drive sheave slips under cables, quickly flip controller inspection switch to inspection to stop car. Run car up to bottom floor level and remove all jumpers above.



NOTE: The SDI board will open the safety string after detecting the pulse count failure provoked above. Reset the SDI after the car stops to restore the safety circuit.

#### **II.4.2. EMPTY CAR COUNTERWEIGHT BUFFER TEST**

II.4.2.1. Place controller test switch to test position.

II.4.2.2. Call elevator to a floor several floors below top except bottom floor.

II.4.2.3. Jumper terminal 4A to all up slowdown switches terminals (USD1, USD2, and UT6 thru UT14 if used for higher speeds).

II.4.2.4. Identify and remove signal DP1 from SDI terminals.

II.4.2.5. Place controller inspection switch to inspection, and run car one or more floors up to a floor level. Reconnect DP1 and place controller inspection switch to normal.

II.4.2.6. Place jumper from controller terminals 17 to 23. This bypasses safety switches. Also, jumper terminals 28 to 30, to bypass up normal limit.

II.4.2.7 Place a car call to top floor to run counterweight into buffer. After counterweight strikes buffer and drive sheave slips under cables, quickly flip controller inspection switch to inspection to stop car. Run car down to top floor level and remove all jumpers above.



NOTE: The SDI board will open the safety string after detecting the pulse counts failure provoked above. Reset he SDI after the car stops to restore the safety circuit.

#### **II.4.3. GOVERNOR TEST**

II.4.3.1 ELECTRICAL OVERSPEED TEST: Manually trip governor overspeeds switch open to verify that safety circuit drops out. Now, with governor cable lifted off the governor, spin governor while measuring speed to verify electrical and mechanical tripping speeds. A variable speed drill motor is very handy for spinning governor. Place governor cable and contact back to normal. Repeat procedure for counterweight governor, if any.

#### **II.4.4. FULL LOAD CAR SAFETY OVERSPEED TEST**

II.4.4.1. Put full load in the car and then place the controller test switch to test position.

II.4.4.2. Call elevator to Top floor.

II.4.4.3. Place jumper from controller terminals 17 to 23. This bypasses safety switches.

II.4.4.4. Note setting of parameter E1-04 (Maximum Frequency) and adjust parameter E1-04 approximately 1.4 times higher. This will cause the car to run 1.4 times faster at high speed. Return car to the top floor and remove car from inspection.

II.4.4.5. Place a car call to bottom floor, and be prepared to measure car speed at trip point. Car will accelerate to overspeed until safety sets firmly. Flip controller inspection switch to inspection to stop car. Restore car safety and contact to normal, as well as governor contact. Return parameter E1-04 to its original value. Remove all jumpers above to place car back to normal operation.

II.4.4.6. Repeat procedure similarly for counterweight safety, if any, speeding empty car from bottom floor up instead.



NOTE: The SDI board and/or drive unit may open up the safety string after detecting the failure provoked above. Reset the SDI and/or the drive after the car stops to restore the safety circuit.

## **II.4.5. EMERGENCY TERMINAL STOPPING AND SPEED LIMITING DEVICES TEST**

### **II.4.5.1. SPEED LIMITING DEVICE TEST**

II.4.5.1.1. Place test switch on controller to test position.

The speed limiting circuits work independently of the SDI computer and work as a "clamp" on the speed pattern output circuits to cause the elevator to slowdown to the clamp set speed, as the slowdown switches, at the terminal floors, operate in sequence. Please note that the number of slowdown switches used increases with elevator contract speed as indicated on tables 5.3-1 and 5.4-1, sections 5.3 and 5.4 in SDI's manual. The speed clamps were set in step I.4.8 of the Final adjusting procedure above. Please refer to SDI's manual section 4.6 Set Speed Clamps to record the "P" value adjusted for each of the clamps used.

II.4.5.1.2. Now follow the procedure in Section 4.6, Set Speed Clamps, in SDI's manual to lower the "P" value for each clamp by 10fpm each.

II.4.5.1.3. Now make a full hoistway run into the top and bottom landing and notice the speed limiting "bumps" caused by speed clamps as the car decelerates into terminal floor. Note that it may be required to lower the "P" values above, per SDI' manual section 4.6, to notice the effects of the clamps. If necessary, test each clamp individually, one at a time, starting from the highest speed clamp down, to verify clamping effect individually. Please note that if you lower the clamping setting too low, you may get a following error fault on SDI. Return "P" values above to the previously recorded, final adjusting values.

### **II.4.5.2. EMERGENCY SLOWDOWN TEST**

II.4.5.2.1. Call elevator to a floor several floors below top except bottom floor.

II.4.5.2.2. Identify and remove signal DP1 from SDI terminals.

II.4.5.2.3. Place controller inspection switch to inspection, and run car one or more floors up to a floor level. Reconnect DP1 and place controller inspection switch to normal.

II.4.5.2.4. Place a car call for the top floor. As the car approaches the top floor, the SDI will initiate an emergency slow down to terminal upon detection of slowdown switches, as a result of failure of normal floor count slowdowns provoked by steps II.4.6.2 and 3 above. Repeat procedure, in similar manner, for bottom terminal floor.

 NOTE: The SDI board will open the safety string after detecting the pulse count failure provoked above. Please reset the SDI after the car stops to restore the safety circuit.

 CAUTION: After completing safety tests, be sure to remove all jumpers above.

 NOTE: Reconnect the wire to terminal Rd if Absolute Floor Encoding is used.



# Section III

## TROUBLESHOOTING GUIDE

### III.1. System Not Functional In General (car won't run)

The solid state portion of the Elevator Controls' Microprocessor Controller is the most reliable part of the entire elevator plant. While it is possible that a problem may occur, one should first look to the power controller and "outside world" for malfunctions. It should also be noted that the same program loop is used for both cars of a duplex installation, and that if one car is running the computer is working properly, even if the other car is inoperative.

#### **IMPORTANT**

For your convenience, and in order to save troubleshooting time and money, the V800 controller is equipped with multiple indicators that are designed to help you troubleshoot at a glance. You are strongly advised to pay particular attention to the indicators on the I/O board, every action the computer wants to take is indicated (DOF for example means door open function, the computer wants to open doors), and every action the "outside" controller wants the computer to perform is also indicated (DOB for example means the door open button is active). Note that a bar on top of signal name indicates that signal is in the active mode when the LED is off, FRS and FRA are a good example, when off they indicate car is on Main or alternate fire mode. The computer error code LED display will flash a particular status/error code as detected by computer, a list of these codes is pasted on the controller door, if not, procure a copy from the Field-reprogramming manual. The computer error/status codes are also displayed in English format on the LCD display, if provided. Finally, if available, an IBM PC compatible may optionally be used for powerful trouble-shooting, diagnostics, monitoring purposes.

If a particular car is not running, first make sure that it is not on Fire Emergency Service. Normal operation of the Fire Emergency circuitry is to have 24-110V on Terminal 443 with respect to Terminal 3.\* If the elevator is not operating under Fire Emergency Service, all power supplies should then be checked. The natural starting point is the three-phase input. There must be 208-480 VAC (as specified ) present between all combinations of phases. Next, verify that each Power Control step-down Transformer has the correct secondary voltage. (Refer to Controller Schematic, Page 1, for terminal and fuse numbers.) Replace fuses as necessary.

The local controller power supplies should be verified. First, Terminals 4A and 4 should measure +110 VDC. Terminal 50 should measure +110 VDC (or voltage indicated on prints). 208-240 VAC should be present between Terminal Strip terminal 1 & 2 (104-120 vac for 120 volt circuits). If any of the above power supply voltages are improper, check the appropriate fuses. (Again, refer to the Power Control system Schematic Diagram).



NOTE: System common is the 3 buss, and unless otherwise noted all DC voltage measurements are with respect to Terminal 3.

In the upper left portion of the Power Controller System Schematic Diagram can be seen a string of normally closed safety contacts and switches connecting Terminal 4A to Terminal 24. In order for the car to run, all of these contacts must be closed, applying +110 VDC to Terminal 24 and pulling in the SAF Relay. With SAF picked, Terminal 4 will also be at a +110 VDC level.

Assuming Terminal 4 is operating properly at +110 VDC, check the operation of the computer system by observing the MPR output indicator on I/O board. This indicator should be lit, signifying that the computer system has control of the car. If the MPR LED is not lit, go to the section on Microprocessor Troubleshooting.

After verifying that the MPR indicator is on, check for proper HLS Module relay operation ( The HLS module is the relay control board in controller). In order for the car to leave a landing in response to system demand, the following relays must be picked: INS, DOL, U (or D depending on desired direction), P, and SAF. H relay will also pick if slowdown for the direction of travel is made up.

Note that direction (SU/SD), and speed signals (HR/HIR) enter the HLS Module from the computer drivers on the I/O board, via the connecting ribbon cable, (pin numbers are indicated on prints, pin one is indicated by red conductor in ribbon cable); if a high speed run toward a call is required. Register a call and check the appropriate up or down arrow (SUA/SDA) LED. If neither arrow is on, make sure no special function has control of the car (INS in, INA out, and FWI -fire warning indicator- is off (Terminal 443 & 444 At 24-110V). If all the above functions are normal, registering a call must establish a direction arrow. If there is still no arrow refer to the section on Microprocessor Troubleshooting.

Some of the above mentioned relay coils are hardware-interlocked through the door safety circuit. In order for the car to move away from a landing, all doors must be closed and locked. A locked condition is indicated by DLK indicator on I/O board lit (+120 VDC on Terminal 11, while an unlocked condition places 0 VDC on Terminal 11). If the door string indicates an unlocked condition, examine and repair the door locks as required. Should the U or D Relays remain out with a properly locked door circuit, check the operation of the relays by briefly jumping Terminals 4 to 30. U should pick. If it does, but jumping 4 to 28 does not, check and repair the UP STOP LIMIT switch. (Similarly try 4-29 and 4-33 for down.) If the U or D Relays pick on these tests (and the P Relay picks with either U or D) but do not with the registration of a call, with SU/SD indicator on I/O board lit, turn controller off and replace the ribbon cable connecting the HLS Module to the I/O. If SU/SD indicator does not lite-up, check that call registered LED indicated call latched, if you cannot get calls to latch-in, refer to the section on microprocessor Troubleshooting.

## III.2. Malfunctions in an Operating System

### III.2.1. Doors Operating Improperly or Not at All

Problem	Solution
Blows fused F8 and/or F7 and/or Resistor (RD1) Overheats (25ohms 225W).	Test For: (1) Damage to relays O, C, or CX. (2) Mechanical trouble on door operator on car.
No operation of doors, DO and DC relays operate OK, fuses F7 and F8 are OK.	Check: (1) All components in the O, C, and CX relay circuits, and (2) Mechanical trouble on door operator on car.
Doors operate one direction only and correct DO and DC relays are operating.	Test for contact closure across the proper relay- DC for close, DO for open.
Doors operate one direction only. Only one DO or DC relay will operate.	Check DOF/DCF indicator on I/O driver board. (Refer to Microprocessor Troubleshooting Guide). Turn "NORMAL-TEST" switch on HLS Module to NORMAL."
Door speed incorrect at either end of travel. Doors slam or drag.	Check: (1) Slowdown cams that operate slowdown resistors on door operator on car top. Readjust if necessary; and (2) Spring operated door closer on hoistway door.
Doors open a few inches or less at one particular landing and appear to be mechanically stuck but reclose so car can leave.	Readjust upper and lower link connections on lift rod for door lock so that lock properly clears lip of enclosure.
Other mechanical problems with doors.	Refer to drawings relating to mechanical portions of door operator.

**III.2.2. Drive problems** (Refer to page 50 in the Installation and Quick Start Manual).

III.2.2.1 A record of the last four drive failures have been recorded and can be viewed thru parameters U3-01 thru U3-08.

III.2.2.2 A fault trace of the last fault can be viewed thru parameters U2-01 thru U2-14.

III.2.2.3. Critical drive values can be monitored thru parameters U1-01 thru U1-28.

### III.2.3. Call Button Problems

Problem	Solution
Car will not respond to a specific call.	If the system does not register a call (or a group of calls) but the car functions normally otherwise, the call information is not reaching the computer data storage memory. First make sure that the call common (terminal 6 for car calls or terminal 50 for hall calls) is live with correct voltage with respect to 3 buss. Then check the terminals on the controller. One easy method of determining whether the problem is internal to the controller or in the external field wiring is to momentarily jumper 3 to the call terminal number in question. If the car responds to the call, the problem is external. If not: (1) Check that when call terminal is jumped to terminal 3, the corresponding LED lights up, then refer to microprocessor troubleshooting section to check the computer CCD (HCDX) -Car (Hall) call disconnect- function inside computer which comes on to indicate computer not accepting calls. (2) Replace the associated input/output board.
Problem	Solution
Car responds to call button but call registration lamp will not light.	After verifying that the bulb is not burned out, check to see if the problem is internal to the controller or in the external wiring. This is most easily observed by noting if associated LED is lit. If it won't show call registration, check for voltage on call common supply. Should the common voltage be correct, replace the associated input/output driver board.

### III.2.4. Position Indicator Malfunctions

The position indicator is strictly under software control .

Problem	Solution
Position indicator out of step with elevator car.	Refer to section 8 in SDI's manual, review sections dealing with Floor count, pulse, terminal, and hoistway not learned errors. Verify proper operation of the DZ input, making sure that the proper signal LED operates when magnetic switch is on a vane. Also check for missing or damaged hoistway vanes.

## III.3. MICROPROCESSOR TROUBLESHOOTING

The basic idea of this section is to determine if the Computer Logic Check-out indicates a faulty board, and if so which, if any, of the microprocessor system logic boards is faulty, so that a good board may be substituted. No attempt has been made to diagnose specific problems that might be on any particular board, since to do so requires specialized test equipment not generally available to elevator service mechanics.

Let us assume that you have come to the conclusion that an output is not coming out of the computer system when conditions appear such that it should. At this point it becomes necessary to determine if the computer is trying to turn on the output or not, and if not, what is preventing it from doing so.

To find out what the computer is "thinking" or trying to do, we need to look into its memory itself. This is done by using the ON-BOARD diagnostics unit in the manner described in the Field Re-programming manual.

As an example, let us say that it is observed that the door open function output fails to operate the door open relay DO in response to a door opening input signal. It is observed that the DOF door open function output LED indicator does not turn-on. We now set the diagnostics switches as described, and locate the DOF function near the bottom of the Memory Flags Listing page which indicates an address of 9B for DOF and observe that, indeed, the LED indicator corresponding to the DOF position is off. This tells us the computer is not turning on the door open output. This must mean that either the open signal input (say door open button DOB address=81) is not coming in, or computer thinks doors are already fully open (DOLF -door open limit front input is zero, address 80), or it is otherwise unsafe to open doors (DZ=0 or HIR=1). Inspection of these flags will indicate either that an input was not supplied to the system properly, or that the computer can not see it. In the later case we suspect that the I/O board (specially if DOB and DOLF do not track input signals), or ribbon cable connecting it to computer board is faulty.

In a manner similar to the example above, any other output/input can be traced to the computer memory in search for the faulty section. The section below illustrates the logic involved in the computer to process the indicated outputs and signals.

### III.3.1. OPERATIONAL LOGIC DESCRIPTION

The following description of computer logic control is described in a synthesized format (Boolean logic flow equations). They are very simple to read and understand if the following guidelines are understood:

a. The logic equations below use signal abbreviations names as listed in the Field Re-programming manual; they are used on the job prints for the input/output signals. These abbreviations are easily learned since they clearly represent the signal name (e.g., DOB=door open button, DC=Down Call cancel, etc.).

b. the small zero superscript used on a signal name indicates that the signal is active when off, or it is required for signal to go off for something to happen. Thus, DOLF<sup>0</sup> is a signal that when on, indicates doors are not fully open, when off indicates that doors are fully open.

c. The plus symbol + is used to indicate an OR function. Thus the equation: DOB+SE reads "either door open button input OR safety edge input". Likewise the & symbol is used to indicate an AND function. Thus the equation DOI & DOLF<sup>0</sup>=DOF reads "door open intent on AND door open limit off will generate a door open function output". Please note that the words AND and OR are used instead of & and + symbols when combining two smaller equations.

## LOGIC FLOW EQUATIONS

### III.3.1.1 Door Open Function Output -DOF:

(Demand) CCF+UC+DC OR (Input) DOB+SE+PHE+DHLD AND DZ = DOI  
DOI & DOLF<sup>0</sup> = DOF.

### III.3.1.2 Door Open Function Rear Output -DOFR:

SAME AS ABOVE, FLAGS ARE SUFFIXED WITH LETTER R: CCFR, UCR, ETC.

### III.3.1.3 Computer Up Output -SU:

Start: DZ & DLK<sup>0</sup> & HIR & DMU = SU  
Hold: HIR+DZ<sup>0</sup> AND SU & DLK<sup>0</sup> = SU

### III.3.1.4 Computer Down Output -SD:

Same as SU above, replace DMU/SU with DMD/SD.

DMU/DMD are the demand flags, they are set any time the computer is requested to move the car in response to a call (SUA+SDA = 1), car lost (BFD+TFD = 1), parking demand (UPF+LPF = 1), fire or emergency recall (FRM+EPR).

### III.3.1.5 High Speed Output -HR:

Start: DLK<sup>0</sup> & EQA<sup>0</sup> & (DMU & USD1 + DMD & DSD1) & LVL & DOI<sup>0</sup> = HR  
Drop: CCT+HCT+CCF+CCR = HR<sup>0</sup> . Call answered.  
OR DMU<sup>0</sup> & DMD<sup>0</sup> & (SU & STU + SD & STD) = HR<sup>0</sup> . Lost demand.  
OR DLK+EQA+(DNS & DSD1<sup>0</sup>)+(UPS & USD1<sup>0</sup>) = HR<sup>0</sup> . Not save for HR.

### III.3.1.6 Call Disconnect and Reject -CCD, HCDX, HCR:

a. CCD - Car Call Disconnect (car calls won't latch):

IN+EPI+FRM+EPS+EQA+MLT+INC+ISR<sup>0</sup>+TFD+BFD+CCDFU+CCDFD = CCD

b. HCDX - Hall Call Disconnect (hall calls won't latch):

FRS<sup>0</sup>+FRA<sup>0</sup>+EQA<sup>0</sup> = HCDX. If duplex both car's flags are considered.

c. HCR - Hall Call Reject (calls latch but car won't respond):

INC+FRM+EQA+TOS+ISR<sup>0</sup>+HLW+SAF<sup>0</sup>+IN+EPS = HCR

Even if HCR=0 (CCD=0), Hall (Car) calls will be ignored by computer (even when latched-in if car stopping table indicates car should not respond to such call. see car stopping table in Field Re-Programming manual.

### **III.3.2. HARDWARE LOGIC:**

#### **III.3.2.1. Computer Power Supply.**

The proper voltage to the SDI and elevator computer boards is +5VDC +/-5%, this voltage should be checked at the power supply +OUT to -OUT terminals. If you need to adjust, be very cautious, turning adjustment for too high an output will cause the unit to trip out. If this happens, lower adjustment back, then cycle power off.

#### **III.3.2.2. Microprocessor Board.**



**CAUTION:** Do not depress the microprocessor reset button while car(s) is running as it will cause car(s) to stop from whatever speed they are moving. Use extreme care.

#### **Function of Lights and Switches.**

On the processor board, there are nine light emitting diodes (LED's), five push-buttons, and some switches. The one LED located by itself near the top of board is an indicator which, if on, says that the processor is at least functioning in a very basic way, but does not necessarily mean that the system is functioning normally. The eight remaining LED's are in a row, and are used to display the error/status codes (so will the LCD display, in English format). In general, the car A/B switch directs the eight LED's to be indicators for CAR A if the switch is UP or CAR B if the switch is DOWN for single computer duplex systems only. Normally, however, the A/B switch is always left in A position since most systems are supplied with one computer per car. Refer to Field Re-programming manual for details on the use of switches on computer board.

There are a group of special conditions that are recognized by the processor and if one of these "errors" occurs, the processor will display the code corresponding to that condition. Then this code is looked up by the serviceman in a chart to see what the situation was that caused the processor to display the error (see Table II for an error code listing, in Field Re-programming manual). Not all errors in the system are detected and displayed by the processor; but the most frequent errors have been programmed to be recognized. Even the fact that the door lock string is open, as it sometimes is during normal operation, is an "error" code, so this code will be frequently displayed during normal operation. The error codes are arranged in priorities so that if more than one problem is present, the most important one will be the one that is displayed (on LCD display provided, multiply error codes are displayed in scrolling fashion). The CAR A/B switch will select the error codes, if any, for whichever car is selected, but both cars cannot be viewed at the same time. So, if the switch is set on CAR A and a problem occurs on the other car, it will not be displayed. In a single car elevator system the CAR A -CAR B switch should be left in the CAR A position. Same is true for most systems supplied with one computer per car.

#### **III.3.2.3. I/O Board (I/O-E X Board)**

Since the I/O board performs the task of buffering between the relatively well protected five volt computer logic environment and the 110 volt electrically noisy outside world, most microprocessor system problems occur on the I/O boards. The input buffer section of the I/O accept high-level inputs from the HLS board or car signals, and convert them to five volts signals for the computer. Also included are low-pass filtering to reduce noise susceptibility, and Schmitt triggers to increase noise margin. The relay and signal driver section of the I/O board provides high voltage switching outputs to actuate relays on HLS module and general elevator signals.



# SECTION IV

## DETAILED EXPLANATION OF SUPERVISORY SUBSYSTEM

### **IV.1. Detailed Explanation of Supervisory control Subsystem Operation**

The operation of a computer is basically serial. That is, the actual logical decision-making process is concerned with one piece of data at a time. Since an elevator is a continuous, real-time machine, the supervisory control subsystem microcomputer or microprocessor is made to operate in a loop, performing a pre-determined pattern of instructions many times each second. Its speed is such that each elevator control function appears to be continuously monitored. The paragraphs that follow offer a brief explanation of the basic control loop and the functions performed by the computer during each portion of that loop.

Before any logic decisions can be made, data must be acquired, so the first portion of the control loop is called "contact scan." At this time the microprocessor interrogates each input (hall calls, car calls, and power subsystem inputs) and saves them in the data storage memory. The data from the memory is then used during the rest of the control loop. In effect, the controller takes a "snapshot" of the entire elevator system, and uses that for decision-making. These snapshots are made many times each second, so that system monitoring is essentially continuous.

After the data has been acquired, proper outputs are computed for fire service.

The next major block in the control loop deals with stepping. This system has no mechanical floor selector. When power is first applied, the Supervisory Control system checks to see if the car is at the top landing (on the up slow down limit) or at the bottom landing (on the down slow down limit). If so, the internal electronic "selector" is set to the proper value. If the car happens to be somewhere in mid-hoistway when power is first applied, the system will obtain current car position from the SDI computer, whereupon it will become synchronized.

As the car passes each floor, the internal electronic "selector" is updated accordingly. The point of this stepping is actually one slow-down distance ahead of each floor. When the car steps into any given floor, the control system determines if there are any calls registered for that floor, and if so initiates a slow down and cancels the calls. This method requires no mechanical attachments to the car, such as chains, wires, or tapes.

After the controller processes data pertaining to a moving car it scans all calls present and selects a direction preference for the car if it is not already answering a call.

The next block in the control loop is concerned with proper operation of the doors. While the car is running, this portion is bypassed, but when the car enters door zone the block becomes very active. Some functions performed by the door processing block are door holding times (hall call time, car call time, and shortened door time) door opening and closing, and permission to proceed at high speed. The car actually moves in response to signals generated during the door portion, since all interlocks and timers as well as car panel button inputs must be correct in order for the car to move.

The final block of the control loop takes the data generated by all previous calculations, as well as the calls stored in memory, and lights the appropriate car panel and hall indicator lamps. The loop is now complete, and the processor starts over with contact scan. As mentioned previously, this whole loop is repeated many times each second, so that operation is smooth and, to all outward appearances, continuous.

It should be noted that the power-up logic, in addition to correctly presetting the floor selector memory location, clears all memory locations and output buffers prior to applying any signals to the power control subsystem to insure safe, stable operation.

# Section V

## MAINTENANCE

The Elevator Controls Microprocessor Elevator Controller has been designed to require as little routine maintenance as possible. In fact, the mechanical interconnections are the least reliable portion of the solid state system, and the less they are disturbed, the more likely the system is to continue to function properly.

The elevator itself, however, is a complex mechanical apparatus, and therefore requires periodic routine preventive maintenance. In addition to lubrication of the various moving parts, the door lock contacts should be cleaned and inspected regularly since the exposed contacts are susceptible to dirt and corrosion. The doors also receive the most wear, often making two or even three cycles at a floor.

In addition to the door lock contacts, the various rotating machinery belts and couplings should be routinely inspected for wear. Worn belts could cause loss of control of elevator car.

If the elevator system develops problems or becomes inoperative refer to the Troubleshooting guide.

# Section VI

## REPLACEMENT PARTS LIST

### **VI.1. ELEVATOR CONTROLS PC BOARDS.**

- 1) MPC-P8 MICRO PROCESSOR BOARD
- 2) MPC-IO6-INT-V<sub>xx</sub> MAIN INPUT/OUTPUT BOARD
- 5) MPC-IOEX-V<sub>xx</sub> INPUT/OUTPUT EXTENSION BOARD
- 6) E.C. TIMER #100D
- 7) MPC-SDI AND SDI I/O MICRO PROCESSOR BOARDS

Note: xx is the FIXTURE VOLTAGE

### **VI.2. RELAYS**

- |                       |                  |                  |
|-----------------------|------------------|------------------|
| 1) POTTER & BRUMFIELD | 2) OMRON         | 3) IDEC          |
| A) KHAU-17A12N-120    | A) MY4AC110/120S | A) RU4S-D12      |
| B) KHAU-17D12N-110    | B) MY4-DC12S     | B) RU4S-A12      |
| C) KUP-14D35-110      |                  | C) RR3B-ULDC110V |
| D) PRD11DH0-110VDC    |                  |                  |

### **VI.3. FUSES**

- 1) LITTLE FUSE
  - A) 312.250 1/4 AMP 250VOLT
  - B) 312-001 1 AMP 250 VOLT
  - C) 312-002 2 AMP " "
  - D) 312-003 3 AMP " "
  - E) 314-015 15 AMP 250 VOLT
  - F) MDA TYPE 3, 5, 10 & 15 AMP 250 VOLT
- 2) BUSSMAN
  - A) FRN-R 10, 20, 30, 60 AMP 250 VOLT
  - B) FNQ 5,10,15A 500 VOLT
  - C) DRIVE POWER FUSES – REFER TO PAGE 4 OF DRAWINGS FOR SIZE AND RATING

### **VI.4. POWER SUPPLY**

POWER ONE HBAA-40W-A MICRO PROCESSOR POWER SUPPLY

### **VI.5. SEMI-CONDUCTORS**

MOTOROLA HEP-RO170  
MOTOROLA 1N5347B – 10V, 5WATT, ZENER DIODE  
MOTOROLA 1N5333B – 3.3V, 5WATT, ZENER DIODE  
TECOR L4004F31 – 4 AMP, 400VOLT, SENSITIVE GATE TRIAC